



Wireless Device Grading Scales Criteria and Definitions

Version 1.0

December 2018

© 2018 CTIA - The Wireless Association®. All rights reserved.

Any reproduction or transmission of all or part of this document, in any form or by any means, electronic or mechanical, including photocopying, recording, or via any information storage and retrieval system, without the prior written permission of CTIA, is unauthorized and strictly prohibited.

Any reproduction of this document shall display the notice: "© CTIA 2018. All Rights Reserved."

CTIA Certification LLC

1400 16th Street, NW

Suite 600

Washington, DC 20036

certification@ctiacertification.org

1.202.785.0081

www.ctia.org/certification

Table of Contents

Section 1	Introduction	6
1.1	Purpose	6
1.2	Scope	6
1.3	Definitions.....	6
Section 2	Grading Scales	7
2.1	Schema	7
2.2	Cosmetic Grade Definitions.....	7
2.3	Surface Area Definitions.....	9
2.4	Defect Definitions Surface.....	13
2.5	Viewing and Inspection	15
2.6	Defect Levels for Scratch and Dots.....	15
2.7	Cosmetic Surface Area Classification	18
2.8	Functional Classifications.....	19
2.9	Lock Status.....	20
2.10	RF Test Grading Scale.....	21
2.11	Kit Configuration.....	21
Section 3	Master Grading Scales Matrix: Cosmetic Grading Scales Cross Reference with Functional Classification	22
	Appendix A— Revision History	23

List of Figures

Figure 2-1 Camera Lens Zoom View	8
Figure 2-2 Top to Bottom Side View	8
Figure 2-3 “AA” Surface Camera Example	9
Figure 2-4 “A” Surface Example	10
Figure 2-5 “B” Surface Example	10
Figure 2-6 Zoom View	11
Figure 2-7 Audio Mesh Grill and Microphone Holes	11
Figure 2-8 USB Connector	12
Figure 2-9 Lightning Connector & USB-C Connector	12
Figure 2-10 Headset connector	12
Figure 2-11 SIM tray inside surface	12
Figure 2-12 Battery Contacts for Customer Removable Battery	13
Figure 2-13 Viewing and Inspection	16
Figure 2-14 Lighting	16
Figure 2-15 Measurement Tool	17

List of Tables

Table 1-1 Definitions	6
Table 2-1 Grading Scales	7
Table 2-2 Defect Levels	15
Table 2-3 Dot Creation and inspection	15
Table 2-4 Cosmetic Grading Scales: Defect By Surface Area Table	18
Table 2-5 Functional Classifications	19
Table 2-6 General Descriptions of Common Failures	20
Table 2-7 Lock Status	20
Table 2-8 RF Test Grading Scale	21
Table 2-9 Kit Configuration	21
Table 3-1 Example Master Grading Scale Matrix	22

Acknowledgements

This document was created by the wireless industry with input from the following companies and their representatives:

Company, Representative	Company, Representative
Apple , Randy Teele	Hyla Mobile , Steve Pappas
Asurion , Justin Nelson	iFixYouri , Chris Johncke
AT&T , Keith Burkman	Ingram Micro , Ron Wacker
B-Stock Solutions , Sean Cleland	Mobile Defenders , Steve Barnes, Jordan Notenbaum
Batteries Plus Bulbs , Dana McLain, Sukaina Yacoob	Motorola , Darwin Garcia
Cellpoint Corporation , Ehsan Gharatappeh,	Phobio , Jacob McMillan
Clover Wireless , Tony Vitek	Recipero , Jack McArtney
Comcast , Cornelius VanGinhoven	Samsung , Robert Nelson, Paul Walker
CVE , Ruben Alvarado	Service Central Technologies , Chris Bleess
Encore Repair , Sean Flaherty, Josh Geller	Sprint , Brian Mantel
FedEx Supply Chain , Tevon Taylor	Staymobile , Rob Lennox
Future Dial , Dennis Pettit, Thomas Rayas	T-Mobile , Patricia Arnold, Kevin Sweeney
Global Resale , Mike Watson	Werx Parts , Courtney Huck
HOB International , Timothy Wagner	

Section 1 Introduction

1.1 Purpose

This document defines the wireless industry common lexicon and process for grading wireless devices. The intention of this document is not to identify specific requirements for operationalizing grading scale tiers. Any business can modify the grading scale tiers and defect sizes or types per surface area to meet their business needs, including establishing bulk lots for resale. Any deviations from these grading scale criteria and definitions shall be disclosed to the customer in order to prevent confusion with the standards defined herein.

1.2 Scope

The scope of this document is limited to Devices as defined in [Table 1-1](#).

1.3 Definitions

TABLE 1-1 DEFINITIONS

Term	Definition
Customer Lock	Customer initiated lock like FMIP (Find My iPhone) for iOS, Find My Device for Android or a simple screen lock.
Device	Smartphone, feature phone, tablet
Fully Functional	Device assured functional to all original applicable OEM specifications
LDI	Liquid Damage Indicator
OCA	Optical Clear Adhesive
OEM	Original Equipment Manufacturer
PCBA	Printed Circuit Board Assembly
RF	Radio Frequency
SIM	Subscriber Identify Module
USB	Universal Serial Bus

Section 2 Grading Scales

2.1 Schema

An industry Grading Scales schema is defined in order to allow any seller in any secondary market of devices to universally identify cosmetic condition, functional classification, data status, lock status and kit configuration condition. [Table 2-1](#) shows the Grading Scales options that define the schema.

TABLE 2-1 GRADING SCALES

Description	Table Reference	Grading Scales Options
Cosmetic Grades	Table 2-4	A, B, C, D, E or N
Functional Classification	Table 2-5	0, 1, 2, 3, 4, 5, 6, 7, 8 or 9
Lock Status	Table 2-7	1, 2, 3, 4, 5, 6, 7, 8 or 9
RF Test Grading Scale	Table 2-8	1, 2, 3, 4 or 5
Kit Configuration	Table 2-9	1, 2, 3, 4, 5 or 6

2.2 Cosmetic Grade Definitions

Grade A: Like New Condition.

- Minimal scratches and blemishes
- External LDI not triggered

See [Table 2-1](#) for details on quantity and types of cosmetic defects allowed per surface area and in total.

Grade B: Light wear and tear

- Will allow more scratches and blemishes than Grade A but no lens cracks on any surface
- External LDI not triggered

See [Table 2-1](#) for details on quantity and types of cosmetic defects allowed per surface area and in total.

Grade C: More aggressive wear and tear.

- Will allow some cracks on certain surface areas such as camera lens, rear lens but not on display cover lens

FIGURE 2-1 CAMERA LENS ZOOM VIEW

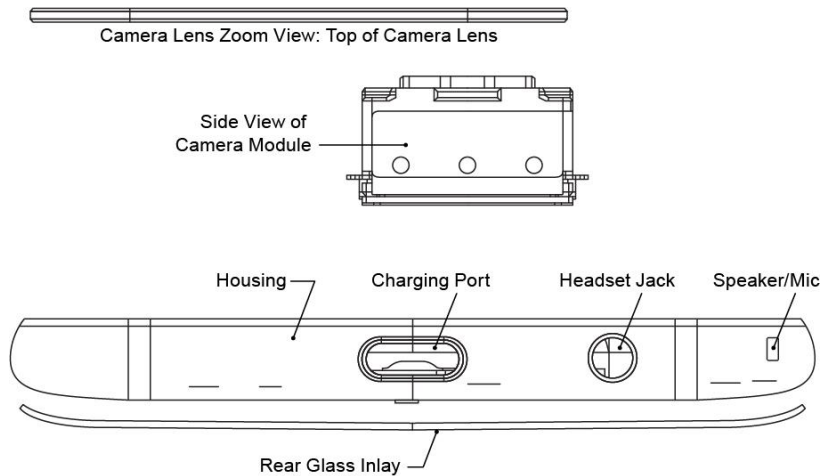

- Externally viewable LDI not triggered

See [Table 2-1](#) for details on quantity and types of cosmetic defects allowed per surface area and in total.

Grade D: Heavy cosmetic damage with cover lens cracks.

- Will have excessive damage on multiple surface areas and cracks on the cover lens but not on internal display structure
- Missing small parts such as side keys, finger print sensor, speakers, flexes, front camera, daughter boards, camera/flash lens and internal mechanical parts (Display, PCBA, Main/Rear Camera, Housing and Battery not consider small)
- Externally viewable LDI triggered but no corrosion

See [Table 2-1](#) for details on quantity and types of cosmetic defects allowed per surface area and in total.

FIGURE 2-2 TOP TO BOTTOM SIDE VIEW

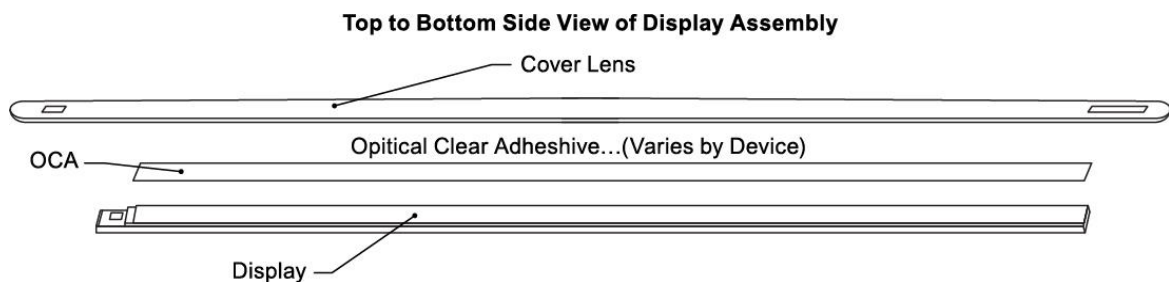

Grade E: Heavy cosmetic damage with display internal structure damage.

- Will have excessive damage on multiple surface areas including internal display structure
- Externally viewable LDI triggered with or without corrosion

See [Table 2-1](#) for details on quantity and types of cosmetic defects allowed per surface area and in total.

Grade N: Not Graded.

- Device was not inspected for cosmetic defects
- Device has unknown cosmetic defects

2.3 Surface Area Definitions

“AA” Surface - Main (any) display + all camera lenses

- Main lens over the display **All displays if multiple displays
- Display viewing area **All displays if multiple displays
- Camera lens **All cameras if multiple cameras

FIGURE 2-3 “AA” SURFACE CAMERA EXAMPLE

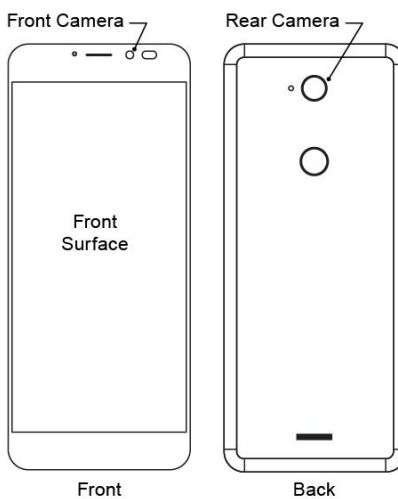

“A” Surface - Front housing/glass area (minus display/camera)

- Front housing – only the surface areas visible when looking directly at device if not part of the back housing
- Any surface area front view that isn’t a “AA” surface
- Finger print sensor

FIGURE 2-4 “A” SURFACE EXAMPLE

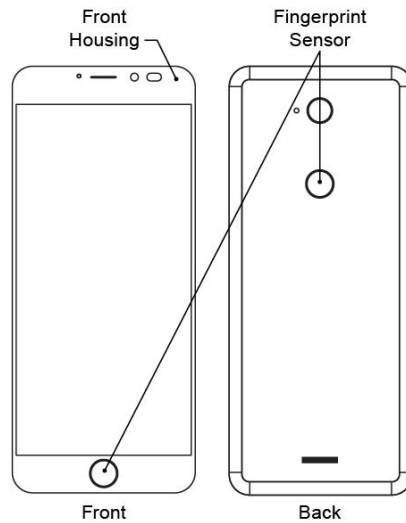

“B” Surface - Sides and back of housing

- Housing – sides/edges/corners/back

FIGURE 2-5 “B” SURFACE EXAMPLE

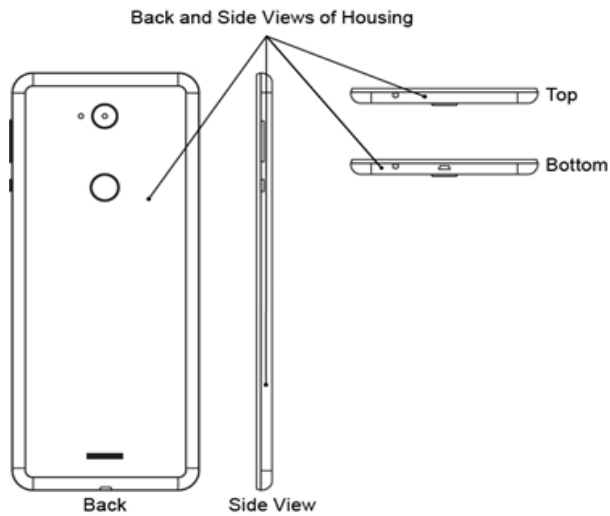
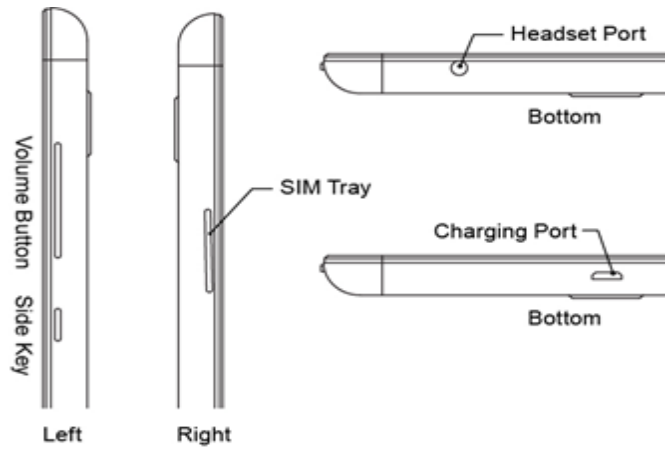
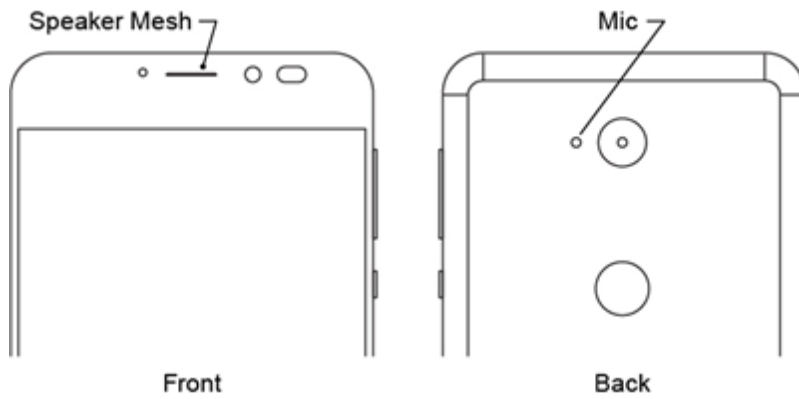

FIGURE 2-6 ZOOM VIEW



- SIM tray cosmetic area
- Logos
- Battery cover/door
- Side keys/buttons
- USB port area
- Headset port area
- Audio mesh grill and microphone holes

FIGURE 2-7 AUDIO MESH GRILL AND MICROPHONE HOLES



- Screws (directly visible on any external surface area)
- Other cosmetic surfaces (bezels, antennas, stylus....etc.)

“C” Surface - Contacts/connections/under covers

FIGURE 2-8 USB CONNECTOR

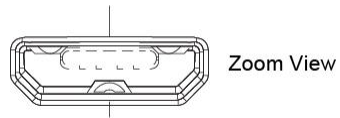

FIGURE 2-9 LIGHTNING CONNECTOR & USB-C CONNECTOR



FIGURE 2-10 HEADSET CONNECTOR

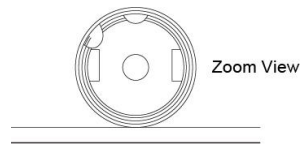

FIGURE 2-11 SIM TRAY INSIDE SURFACE

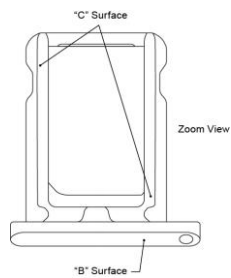
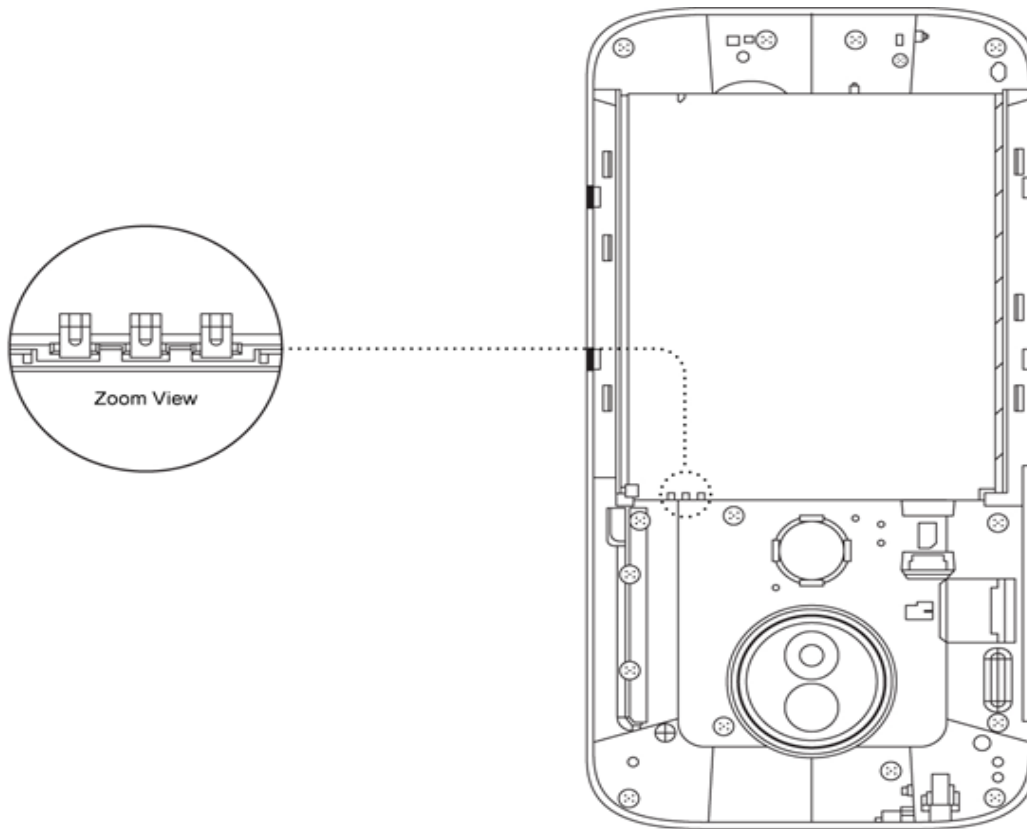

FIGURE 2-12 BATTERY CONTACTS FOR CUSTOMER REMOVABLE BATTERY



- Internal labels and logos (under a customer removable cover/door)
- Surfaces covered by the customer removable battery cover
- Screws covered by the customer removable battery cover
- External battery (user replaceable)

2.4 Defect Definitions Surface

“AA” Surface: Display(s) and camera(s)

- Scratch and Dots: Elongated and/or round marks on the surface of the device.
- Crack: A physical fracture in the surface of the material; glass that has broken or is starting to break.
- Fingerprints under glass/lens: Skin oils or impressions from handling the lens and display during the repair/refurbishment process.
- Foreign Material: Dust or other matter inside main, camera or flash lens.
- Lint: Hair and fibers found behind main, camera or flash lens.
- Smudge: Permanent stain or blotch on the main, camera or flash lens.

- Alignment: Display to lens viewing area is aligned and centered.
- Air Bubble: Air entrapment within and between the display and lens.
- Lifted lens: Lens to housing dimension out of spec. (de-lamination or separation gaps).

“A” Surface: Front view of device

- Scratch and Dots: Elongated and/or round marks on the surface of the device.
- Crack: A physical fracture in the surface of the material; glass that has broken or is starting to break.
- Lifted lens: Lens to housing dimension out of spec. (de-lamination or separation gaps).
- Discoloration: Any change from original color and inconsistent gloss.
- Dent: Indentation or nick that can be felt to the touch.
- Shiny Blemish: A smoothness in the texture of the plastic, usually wide and cannot be felt.
- Stains: Foreign colorant, corrosion, rust or oxidation.
- Warp: Deformation of plastic housing by bowing across flat plane.
- Gaps: Gaps between surfaces within specs.

“B” Surface: Sides and back of housing

- All from “A” Surface.
- Burr: Rough edges and sharp corners.
- Dusted Mesh: Dust or other matter inside mesh or microphone port.
- Screw Defect: Missing, wrong type, stripped head and loose.

“C” Surface: Contacts/connections/under covers

- Contaminated Connector: Foreign material inside the connector.
- Damage Connector: Missing, bent, corrosion and excessive wear and tear.
- Battery Damage (customer removable): Warped, burned, punctured, swelled, wrinkle and missing labels.
- SIM Tray Damage: Bent and loose (cannot hold SIM or SD card).
- Glue: Residue left after removing or peeling off labels.
- Damage Labels: Peeling, missing. Must be fully legible.

2.5 Viewing and Inspection

1. Visual inspection is performed at arm's length with slight bend in elbow (**18 inches from face to device**) with normal 20/20 vision (or corrected to 20/20 vision).
2. The unit should be viewed straight on and without having to rotate the unit to determine a defect.
3. Inspection is performed in lighting typically found in a factory environment. The type and degree of lighting is technically described as a cool, white fluorescent light source.
4. Each surface of part shall be scanned once without dwelling on any single surface (**4 seconds for each surface area and 6 seconds for "AA"**). Magnification is allowed only for verification of defect size. Use of tools/gauges is encouraged to aid in acceptance decisions.
5. "AA" surface should be tilted back 45 degrees to help identify all cracks/scratches in the surface.

2.6 Defect Levels for Scratch and Dots

TABLE 2-2 DEFECT LEVELS

	Length in Millimeters	Width in Millimeters	Length in Inches	Width in Inches
LEVEL 1	≤ 0.5mm	≤ 0.05mm	≤ 0.02 inch	≤ 0.002 inch
LEVEL 2	≤ 1.5mm	≤ 0.5mm	≤ 0.06 inch	≤ 0.02 inch
LEVEL 3	≤ 2.0mm	≤ 0.5mm	≤ 0.08 inch	≤ 0.02 inch

TABLE 2-3 DOT CREATION AND INSPECTION





Dot Criteria		Dot Inspection	
Max Dot Size	1 Dot ≤ 0.5mm each	Imperfections of various shapes 	Inspection Dot 
Cumulative Dots Rule	2 Dots ≤ 0.4mm each	 Pass: Imperfection is smaller than the inspection dot	
Max Cumulative Dots	1 Dot + 1 Dot ≤ 0.8mm	 Fail: Imperfection is larger than the inspection dot	
Marginal/Questionable	Use Magnification	Note: Dots are not to scale	

FIGURE 2-13 VIEWING AND INSPECTION

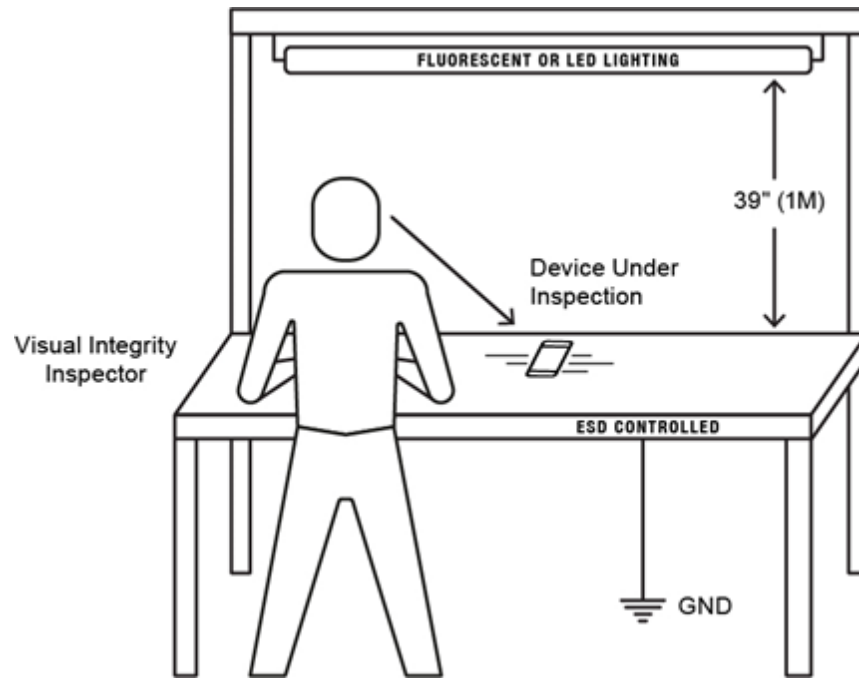

FIGURE 2-14 LIGHTING

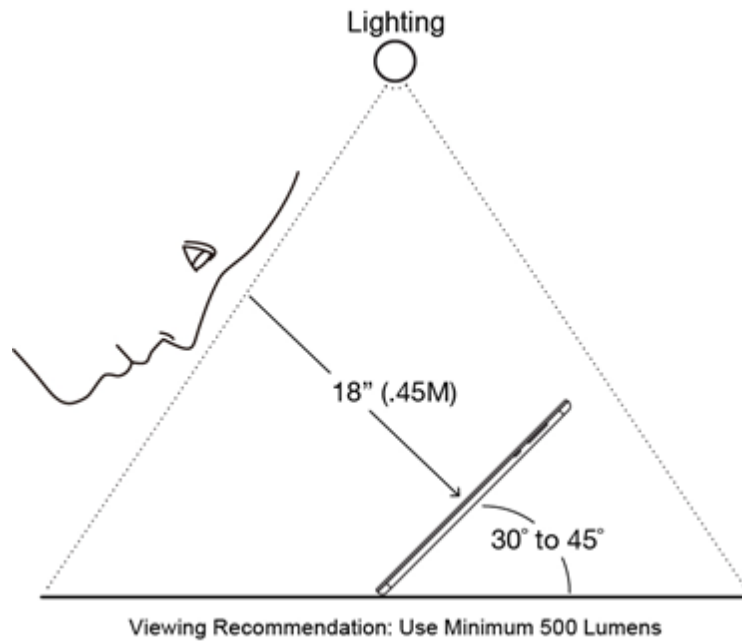
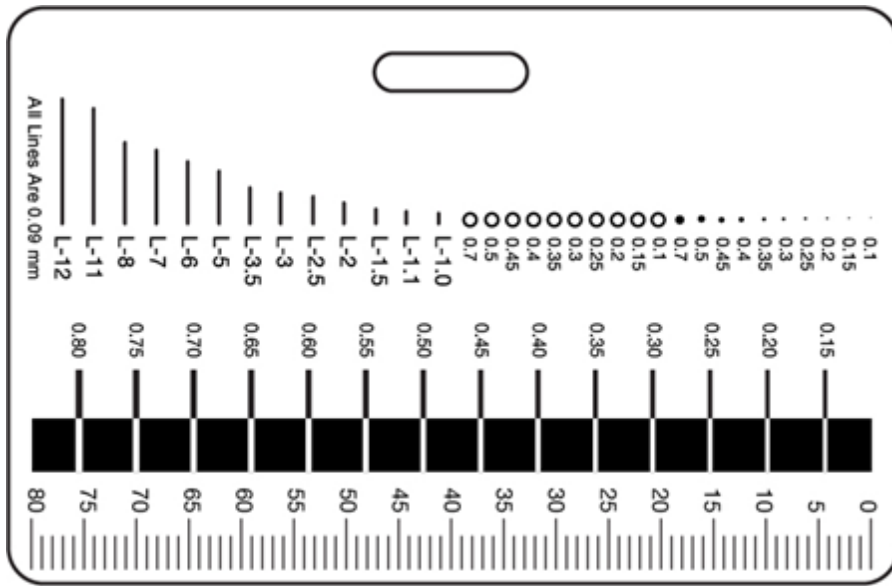

FIGURE 2-15 MEASUREMENT TOOL



Note: Not to Scale. Representative of a Standard Overlay Measurement Tool.

Figure 2-15 is an example of a generic standard measurement tool to be used in evaluating damage marks on devices.

2.7 Cosmetic Surface Area Classification

TABLE 2-4 COSMETIC GRADING SCALES: DEFECT BY SURFACE AREA TABLE

Grade		Surface Area "AA"	Surface Area "A"	Surface Area "B"	Survey Area "C"
Grade A	Level 1 Defect Allow #	0	3	4	N/A
	Level 2 Defect Allow #	0	2	3	N/A
	Level 3 Defect Allow #	0	0	1	N/A
	Automatic Defect Failures	All	All	All	All
Grade B	Level 1 Defect Allow #	5	10	20	N/A
	Level 2 Defect Allow #	2	5	10	N/A
	Level 3 Defect Allow #	2	3	5	N/A
	Automatic Defect Failures	Cover Lens Cracks Display Damage Camera Lens Cracks Display Alignment Pressure Spots Air Bubbles Lifted Lens	Discoloration Gaps Cover Lens Cracks Lifted Lens	Rear Lens Cracks Battery Damage Burr Discoloration Warp Gaps Screw Defect	Damage Connector SIM Tray Damage Missing Parts
Grade C	Level 1 Defect Allow #	Unlimited	Unlimited	Unlimited	N/A
	Level 2 Defect Allow #	20	Unlimited	Unlimited	N/A
	Level 3 Defect Allow #	10	20	Unlimited	N/A
	Automatic Defect Failures	Cover Lens Cracks Display Damage Display Alignment Pressure Spots Air Bubbles Lifted Lens	Discoloration Cover Lens Cracks Lifted Lens	Battery Damage Warp	Damage Connector Missing Parts
Grade D	Level 1 Defect Allow #	Unlimited	Unlimited	Unlimited	N/A
	Level 2 Defect Allow #	Unlimited	Unlimited	Unlimited	N/A
	Level 3 Defect Allow #	Unlimited	Unlimited	Unlimited	N/A
	Automatic Defect Failures	Display Damage	Warp	Battery Damage Warp	Damage Connector
Grade E	Level 1 Defect Allow #	Unlimited	Unlimited	Unlimited	N/A
	Level 2 Defect Allow #	Unlimited	Unlimited	Unlimited	N/A
	Level 3 Defect Allow #	Unlimited	Unlimited	Unlimited	N/A
	Defects Included	All	All	All	All

2.8 Functional Classifications

Table 2-5 further defines Functional Classification for grading scales criteria as referenced in Table 2-1.

TABLE 2-5 FUNCTIONAL CLASSIFICATIONS

Type	Power On	Battery Health $\geq 70\%$	Display On	Display Failure	Other Failure
0= Fully Functional	Yes	Yes	Yes	No	No
1	Yes	No	Yes	No	No
2	Yes	No	Yes	Minor	No
3	Yes	No	Yes	Minor	Minor
4	Yes	No	Yes	Minor	Major
5	Yes	No	Yes	Major	Minor
6	Yes	No	Yes	Major	Major
7	Yes	No	No	Unverified	Unverified
8	No	No	Unverified	Unverified	Unverified
9	Not Tested or Functionality Unverified				

See definitions in Table 2-6 General Descriptions of Common Failures.

Recommended battery health threshold should be equal to or greater than **70%** for fully functional classification as defined in above chart.

TABLE 2-6 GENERAL DESCRIPTIONS OF COMMON FAILURES

Degree of Failure	Display Failure	Other Failure
Minor	<ul style="list-style-type: none"> Missing pixels but no more than three Burn-in image on bar or menu areas Touch failure for product in which the touch panel is part of the cover lens 	<ul style="list-style-type: none"> Side keys Front camera and flash Proximity and light sensor Speakers or microphones Headset jack Vibrator Finger print sensor if not linked to the main board Battery health
Major	<ul style="list-style-type: none"> Missing pixels, more than three Burn-in image in center area Missing or discolor lines Touch failure for product in which the touch panel is part of the display Dark, white and discoloration spots Backlight brightness 	<ul style="list-style-type: none"> Rear camera Dead battery Finger print sensor if linked to the main board Cannot detect SIM or SD card Does not charge Cannot connect to PC Wi-Fi, Bluetooth, GPS

Examples of minor and major common failures as referenced in [Table 2-5](#) above.

2.9 Lock Status

TABLE 2-7 LOCK STATUS

Type	Cleared Customer Content/Data Wipe	Customer Locked Table 1-1	Carrier Locked
1	Yes	No	No
2	Yes	No	Yes
3	Yes	Yes	No
4	Yes	Yes	Yes
5	No	No	No
6	No	No	Yes
7	No	Yes	No
8	No	Yes	Yes
9	Unverified	Unverified	Unverified

[Table 2-7](#) further defines Lock Status for grading scales criteria as referenced in [Table 2-1](#).

2.10 RF Test Grading Scale

TABLE 2-8 RF TEST GRADING SCALE

Type	Test Details
1	No RF test was conducted
2	Passed RF test conducted by making a live call
3	Failed RF test conducted by making a live call
4	Passed RF test conducted using an RF shielded box
5	Failed RF test conducted using an RF shielded box

Table 2-8 further defines RF Test Grading Scale for grading scales criteria as referenced in Table 2-1.

2.11 Kit Configuration

TABLE 2-9 KIT CONFIGURATION

Type	Kit Configuration Details
1	Kitted with OEM charger (block and cord)
2	Fully kitted with OEM charger (block and cord) and headset
3	Kitted with aftermarket charger
4	Fully kitted with aftermarket charger and headset
5	Bulk device, not kitted with any accessories
6	Transceiver only (No battery or back cover if designed to be customer removable parts)

Table 2-9 further defines Kit Configuration for grading scales criteria as referenced in Table 2-1.

Section 3 Master Grading Scales Matrix: Cosmetic Grading Scales Cross Reference with Functional Classification

Table 3-1 below is an *example* of how to create a cosmetic and functional classification matrix. Any combination or cross reference can be utilized to fit multiple business requirements as needed.

TABLE 3-1 EXAMPLE MASTER GRADING SCALE MATRIX

Master Grade	Cosmetic	Functional	Lock Status	RF Test	Field usage
A+	A	0 or 1	1	2 or 3	0-15 days
A	A	0 or 1	1	2 or 3	Any
B+	B	0 or 1	1	2 or 3	Any
B	B	0, 1, 2 or 3	1, 2 or 3	1, 2 or 3	Any
C+	C	0 or 1	1	2 or 3	Any
C	C	0, 1, 2 or 3	1, 2 or 3	1, 2 or 3	Any
D+	D	0, 1, 2 or 3	1	Any	Any
D	D	0, 1, 2, 3 or 4	1, 2, 3 or 4	Any	Any
E+	E	0, 1, 2, 3, 4, 5 or 9	1, 2, 3 or 4	Any	Any
E	E	Any	Any	Any	Any

Appendix A— Revision History

Date	Version	Description
December 17, 2018	1.0	Initial release of document